

# FUSION®

USER / INSTALLATION MANUAL

MS-RA205  
MARINE STEREO



# PRECAUTIONS

Do not attempt to open the unit. There are no user serviceable parts or adjustment's inside.

No responsibility can be taken for use of the unit other than under normally expected operating conditions.

If exposed to direct sunlight or operated for extended periods metal surfaces may become hot. Take care when handling.

## USING iPod

This unit has been tested with compatible authentic iPod models under normal expected operating conditions, free from any pre-existing defects in either the unit or the iPod.

No responsibility can be taken for use of the unit other than under normally expected operating conditions in conjunction with fully functional and undamaged iPod units which have been manufactured and authorized by Apple Inc.

## USB FLASH DRIVES

- **Drive format:** All USB flash drives used with this unit must be formatted to either FAT32 or NTFS format. These are the most commonly used format for USB flash drives.
- **Audio track format:** Audio tracks stored on USB flash drive must be in MP3 format to play on this unit.

## CARE AND MAINTENANCE

As with all products with a chrome finish exposed to the harsh marine environment, a little care will help preserve the finish and prevent corrosion. FUSION recommends that you clean any salt water and/ or salt residue from the stereo with a damp cloth soaked in fresh water.

Most marine Stereo's have small vents in their cases to allow a way out for moisture that finds its way in. In some limited instances it is possible for moist air to be drawn into the vents when the air inside the Stereo cools down after it is turned off. Direct sunlight on the front can draw this moisture up against the Window, causing fogging. Turning on the Stereo will speed up moisture removal. Fogging is not abnormal, nor will it harm your Stereo, which is built to withstand the harsh marine environment.

## REGISTER YOUR PRODUCT ONLINE

For your own peace of mind, register your product purchase online at [www.fusionelectronics.com](http://www.fusionelectronics.com)

We'll keep you up to date with any news related to your product or new accessories to help you get the most from your product.

## RECORD YOUR PRODUCT DETAILS HERE:

SERIAL NUMBER \_\_\_\_\_ DATE OF PURCHASE \_\_\_\_\_

AFFIX RECEIPT HERE

# CONTENTS

INSTALLATION .....	4
WIRING DIAGRAM .....	6
CONNECTIONS .....	6
BUTTON DESCRIPTION .....	8
GENERAL OPERATION .....	10
RADIO OPERATION .....	12
USB/MP3 OPERATION .....	13
AUX OPERATION .....	13
iPod/iPhone OPERATION.....	14
SiriusXM SATELLITE RADIO .....	15
ZONE OPERATION .....	16
ADDITIONAL FEATURES.....	17
MENU STRUCTURE .....	18
TROUBLESHOOTING .....	19
FUSION MARINE ACCESSORIES .....	21
SPECIFICATIONS AND LICENSING .....	22

## INSTALLATION

IF ANY MODIFICATION TO THE VESSEL IS REQUIRED, SUCH AS DRILLING HOLES ETC FUSION RECOMMENDS CONSULTATION WITH YOUR BOAT DEALER OR MANUFACTURER BEFOREHAND.

Create mounting hole for product and drill Screw Pilot Holes.  
Refer to mounting template included with product or download from [www.fusionelectronics.com](http://www.fusionelectronics.com)

- Fit mounting gasket
- Insert the unit into the mounting hole
- Use the supplied 4 x self tapping screws, to affix the unit into position.
- Attach screw covers

**Note:** Appropriate mounting is very important to ensure correct operation. Select a location that allows both free/open airflow around rear of chassis, whilst minimizing exposure to moisture. Allow adequate room at the rear of the unit for the cable looms (approx 2") and underneath the unit (approx 2") if using a SiriusXM tuner (USA Only).



**Note:** The head unit must not be mounted on more than a 45° angle from the horizontal plain. Failure to follow mounting restrictions could void your warranty.

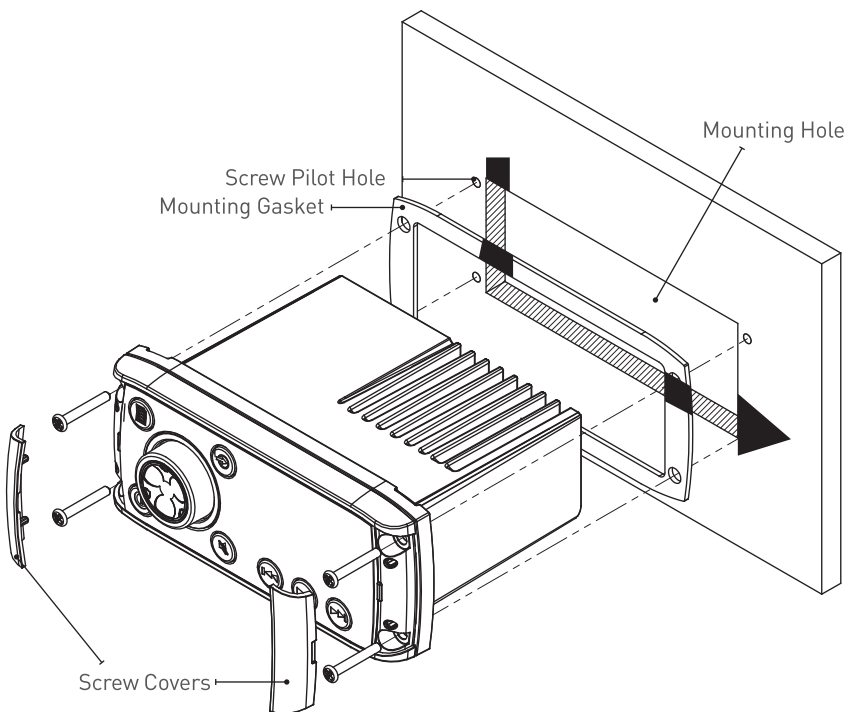

## ELECTRICAL WIRING

**Caution:** The MS-RA205 is designed for vessels with a 12V DC Negative ground electrical system

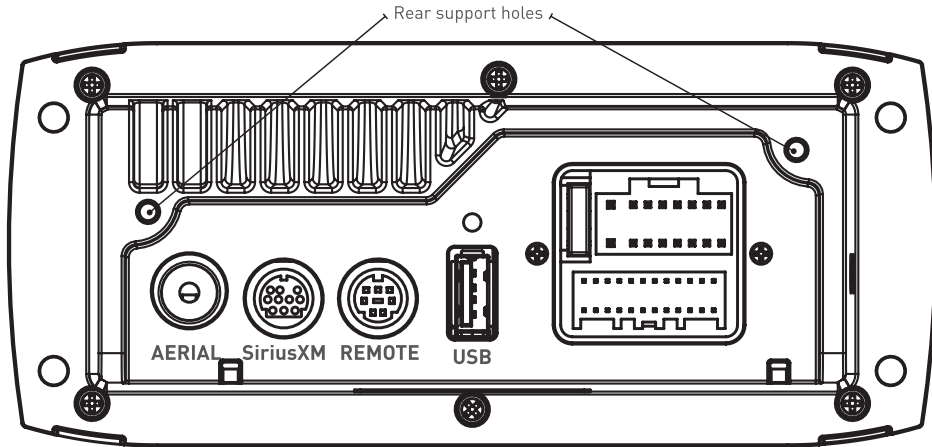

In some cases a rear support strap (not supplied) may be required. Please use the two holes indicated above, to attach the strap using two 8 gauge x 8mm self-tapping screws (not supplied).

## INSTALLATION WARNING

- Ensure the marine vessels +12V lead is removed from the battery before any equipment is connected
- Investigate the marine vessels fuel tanks and electrical wiring locations before you begin installation
- Ensure all wiring is protected to avoid damage

When wiring the MS-RA205, ensure that the wires are away from sharp objects and that rubber grommets and insulated bungs are used when routing the wiring. Ensure that when connecting the wires to the speakers and audio system, the terminals and connections are protected from shorting to each other.

**Note:** Ensure the antenna cable is routed away from any power cables, and is the minimal length, as long cable runs will affect AM reception performance.

For optimum radio reception please ensure you use a dedicated AM/FM ground independent marine antenna.

The use of a VHF splitter is not recommended as this will degrade your marine VHF radio performance.

Please refer to the following site for further info: [www.pacificaerials.co.nz](http://www.pacificaerials.co.nz)

**Note:** The head unit must be correctly bulkhead mounted to reach the IPX5 water ingress rating. Failure to do so could void your warranty.

# WIRING DIAGRAM

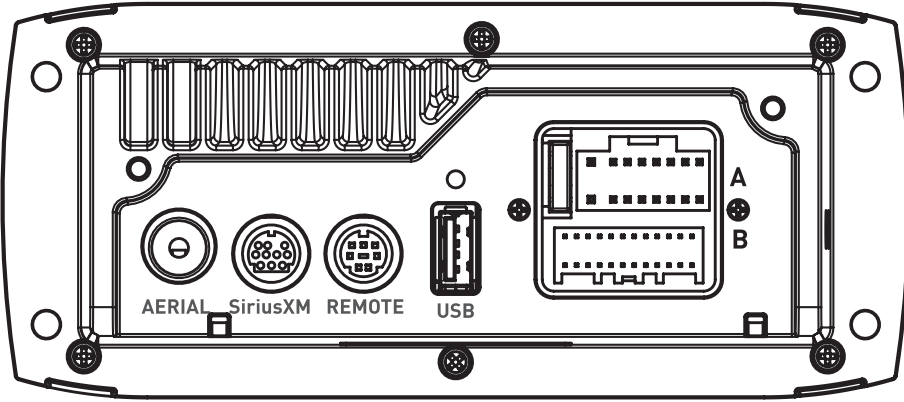

## A CABLE

YELLOW	BATTERY (+12 V constant)
RED	IGNITION (+12V switched)
BLACK	GROUND (-12V)
WHITE	SPEAKER ZONE 1 L (+)
WHITE/BLACK STRIPE	SPEAKER ZONE 1 L (-)
GREY	SPEAKER ZONE 1 R (+)
GREY/BLACK STRIPE	SPEAKER ZONE 1 R (-)
GREEN	SPEAKER ZONE 2 L (+)
GREEN/BLACK STRIPE	SPEAKER ZONE 2 L (-)
PURPLE	SPEAKER ZONE 2 R (+)
PURPLE/BLACK STRIPE	SPEAKER ZONE 2 R (-)
BROWN	DIM (+12V switched)
BLUE/WHITE STRIPE	AMPLIFIER ON
BROWN/WHITE STRIPE	TEL MUTE/INTERRUPT AUX

## B CABLE

WHITE RCA (Grey wire)	AUX-IN (L)
RED RCA (Grey wire)	AUX-IN (R)
ORANGE RCA (Black wire)	SUB-OUT
ORANGE RCA (Black wire)	SUB-OUT
WHITE RCA (Black wire)	LINE-OUT ZONE 1 (L)
RED RCA (Black wire)	LINE-OUT ZONE 1 (R)

**Note:** Minimum load impedance 4 Ohm

# CONNECTIONS

## A CABLE

### BATTERY +12VDC

Connect to the battery positive (+12VDC), or bus bars. A fuse or circuit breaker **MUST** be used at the battery end of the cable. Use a minimum wire size of 16AWG for wire length up to up to 7 meters / 20 feet.

### IGNITION +12V switched

Connect to a separate switched +12V wire to control stereo ON/Off operation. Alternatively connect to the battery positive (+12VDC), or bus bars.

When the red “Accessory +12V switched” wire is not required for ignition on/off control, it MUST be connected together with the Yellow “Battery +12V” wire at the MS-RA205 head unit wiring loom.

Recommended minimum wire size for Negative Ground wire:

16AWG for wire length up to up to 7 meters / 20 feet.

### **DIM**

Connect to vessel lighting system to dim LCD and button illumination when vessel lights are turned on. When connecting the DIM input ensure the wire gauge used is suitable for the fuse supplying the circuit being connected to.

### **AMPLIFIER ON**

When using an external amplifier connect to the “Remote turn ON” connection on the external amplifier.

### **TELE MUTE / INTERRUPT**

Connect to handsfree kit to either mute the stereo or switch to AUX to hear call. When this line is taken to ground the stereo is muted.

## **B CABLE**

### **AUX INPUT**

Connect an Auxiliary source to the left and right RCA (White = L, Red = R).

### **SUBWOOFER OUT (DUAL MONO)**

Connect to a subwoofer amplifier, volume control linked to Zone 1. (Orange + Orange)

### **LINEOUT ZONE 1**

Connect to an amplifier, volume control linked to Zone 1. (White = L, Red = R).

### **ANTENNA CONNECTION**

Connect an AM/FM marine antenna.

**Note:** Boat installations do not typically offer the best ground plane environment. For optimum performance a ground plane independent antenna is recommended.

### **USB/iPod CONNECTION**

Connect a USB storage device (not included) or a compatible FUSION Marine Dock (not included) or a certified Apple iPod sync cable (not included).



**SiriusXM SATELLITE RADIO (USA only)** — Requires optional SiriusXM Vehicle Connect Tuner (not included). Refer to SiriusXM Satellite Radio section (page 15).

**WIRED REMOTE / NMEA 2000** — Connect a marine wired remote (MS-NRX200) or connect to a NMEA 2000 network with the addition of the FUSION NMEA connection cable kit (MS-N2KCONN) or create a new NMEA 2000 network with a FUSION NMEA starter cable kit (MS-N2KSTART).



**Note:** An adaptor cable is provided with the MS-RA205 for connection to a NRX200 remote or NMEA2000 network

# BUTTON DESCRIPTION



<p><b>ROTARY ENCODER</b>  <b>Turn</b>          To adjust volume, move up or down a menu structure, or adjust a specific setting.</p> <p><b>Press</b>          To select a highlighted option, confirm a setting. Press to step through each zone for volume adjustment.</p> <p><b>Press and Hold</b>          For quick access to subwoofer level adjustment</p>	
<p><b>POWER</b>  <b>Press to turn the unit ON/OFF.</b></p> <p><b>Press and Hold</b>          Press and hold for 10 seconds to 'Reset' the stereo.</p>	
<p><b>MENU</b>          Press to enter Menu System.          Press to return to previous screen.          Press and Hold          To exit the menu system.</p>	



<p><b>BACK/PREVIOUS</b>  <b>Short Press</b>  iPod/USB - Select the previous track.  AM/FM/SiriusXM/VHF - Start tuning down the station/channel. (Auto/Manual tuning mode) or previous preset (Preset mode).  <b>Press and Hold</b>  iPod/USB - Rewind the current track.  AM/FM/VHF - Fast station/channel stepping.</p>	
<p><b>FORWARD/NEXT</b>  <b>Short Press</b>  iPod/USB - Select the next track.  AM/FM/SiriusXM/VHF - Start tuning up the station/channel. (Auto/Manual tuning mode) or next preset (Preset mode).  <b>Press and Hold</b>  iPod/USB - Fast forward the current track.  AM/FM/VHF - Fast station/channel stepping.</p>	
<p><b>SOURCE</b>  Press to cycle through sources  AM - FM - VHF - iPod - AUX - USB - SiriusXM (USA only)</p>	
<p><b>PLAY/PAUSE</b>  iPod/USB - Pause / resume the current track.  AM/FM/SiriusXM/VHF - Switch between Auto/Manual and Preset tuning mode.  <b>Press and Hold</b>  AM/FM/SiriusXM/VHF - Store the current station/channel as a Preset.</p>	
<p><b>MUTE</b>  Mutes sound in all zones.</p>	

# GENERAL OPERATION

## INITIAL SETUP

Important: The Tuner Region must be selected for correct operation. Default - USA.  
See section: Tuner Region Selection

## ADJUSTING THE VOLUME

Turn the 'Rotary Encoder' to adjust the volume.



## ZONE VOLUME

Press the 'Rotary Encoder' to step through zones.



## SETTINGS

Press the 'Menu' button and select 'Settings'. Select the desired setting to adjust.

**Note:** Whilst in Settings the 'Menu' button acts as a back/return to the previous screen.

» Any key press exits the menu screen.

### -tone

Adjust the Bass/Middle/Treble settings. Press the 'Rotary Encoder' to cycle between Bass/Middle/Treble

### LCD

Press the Rotary Encoder to cycle between Contrast and Brightness. Turn to adjust.

### KEY SOUND

Press the Rotary Encoder to cycle between 'On' and 'Off'.

### ZONE SETUP

The MS-RA205 Marine Stereo features Multi-Zone technology which enables 2 'Zones' with independent volume/balance control.

Select the Zone you wish to setup.

Select 'Balance' to adjust the audio balance from left to right within the selected zone.

Select 'Volume Limit' to set the maximum volume limit within the selected zone.

Select 'Zone Name' to give the zone a name of your choice. Rotate the rotary encoder to change the character. Press the rotary encoder to select. Press the 'Previous' button to delete characters

- To save changes press the 'Play' key

- To exit without saving any changes: press the 'Menu' key.

### SUBWOOFER

Select 'Settings' then 'Zones' then 'Subwoofer'.

Select 'Sub level' to set the desired maximum subwoofer output volume.

Select 'Sub Filter' to select the desired cut-off frequency. 55Hz - 85Hz - 120Hz - 160Hz  
Default: 85Hz

**Note:** From any source screen press and Hold the 'Rotary Encoder' for quick access to subwoofer level adjustment

### LANGUAGE

Select the desired language for the on screen display

English - Deutsch - Nederlands - Espanol - Italiano - Francais

## POWER SAVE

Press the Rotary Encoder to cycle between 'On' and 'Off'.

OFF LCD/Button backlight on constantly

ON LCD/Button backlight turns off after one minute of non-activity

## TEL MUTE

Control the connection to a cell phone hands-free kit.

**MUTE:** Mutes the audio output from the MS-RA205 Marine Stereo when a call is received on your cell phone.

**AUX:** Allows the received call to be broadcast through the Auxiliary input.

**Note:** This feature may not operate with all available hands-free kits.

Hands free kit must be connected to the TELMUTE input and AUX input.

## TUNER REGION

Select the appropriate Region. ▶Europe▶USA▶Japan▶Australasia▶

**Important:** The correct Tuner Region must be selected. Default - USA.

## MARINE REGION

Select the appropriate VHF Marine Region. ▶USA▶Canada▶International▶

**Important:** The correct Marine Region must be selected. Default - USA.

**Note:** The MS-RA205 can be completely disconnected from the constant +12V voltage supply (Battery switch) with no settings lost.

## DISABLE SOURCES

Use this option to turn on/off the AM and VHF sources. For example this is useful if you only wish to listen to FM and do not wish to step through AM and/or VHF when selecting a tuner source.

**Note:** USB/iPod source only available if a device is connected.

## SET DEVICE NAME

Select 'Set Device Name' to give the MS-RA205 a network name of your choice. The name is visible to other devices (Marine Wired Remotes MS-NRX200) connected to the same FUSION network. Rotate the rotary encoder to change the character. Press the rotary encoder to select. Press the 'Previous' button to delete characters.

· To save changes press the 'Play' key.

· To exit without saving any changes: press the Menu key.

## UPDATE

**MS-205:** This option is provided for future MS-RA205 software updates.

**NRX-200:** This option is provided for future software updates to remote controls (MS-NRX200) attached to your MS-RA205.

**Note:** FUSION recommends updating all remote(s) software via the MS-RA205 at time of installation to ensure compatibility. This can be done via the Update menu. Please refer to your remote manual for more information.

## FACTORY RESET

The factory reset function will return all settings in the MS-RA205 to the factory default value.

**Warning:** All AM, FM and VHF station presents are erased. Tuner and VHF tuner regions are reset to USA. All zones are enabled and zone settings, tone, subwoofer filter settings, source settings and device name are returned to default values.

## ABOUT

This option displays the MS-RA205 Marine Stereo software version, remote control version and F-Link software versions.

# RADIO OPERATION

## SOURCE SELECTION

Press the 'Source' button and cycle to desired source. **AM → FM → VHF → SiriusXM (USA only)**

## STATION SEARCH

Press 'Play' to cycle between tuning seek modes. **Auto → Manual → Preset**

### AUTOMATIC SEEK TUNING

Press 'Play' to cycle to Auto tuning mode. Press the 'Previous' or 'Next' button to scan to the next station.

### MANUAL SEEK TUNING

Press 'Play' to cycle to Manual tuning mode. Press the 'Previous' or 'Next' button to step up and down the spectrum. Press & Hold the 'Previous' or 'Next' button for fast frequency stepping.

### PRESET TUNING MODE

Press 'Play' to cycle to Preset tuning mode. Press the 'Previous' or 'Next' button to select previous or next preset.

**Note:** Preset function is only available when more than one preset has been saved.

## PRESETS

### STORING A STATION AS A PRESET

When listening to a station/channel (AM/FM/VHF), press and hold the 'Play' button to store preset. Alternatively: Press the 'Menu' button and select 'Presets'. Select 'Save Current'.

Note: There are 15 presets available per band.

### VIEW PRESETS

Press 'Menu' and select 'Presets'. Select 'View Presets'. Use the 'Rotary Encoder' to cycle and select a saved preset.

### REMOVE PRESET

Press 'Menu' and select 'Presets'. Select 'Remove Preset'. Select the desired preset.

### REMOVE ALL PRESETS

Press 'Menu' and select 'Presets'. Select 'Remove All Presets'.

## VHF OPERATION

### SQUELCH

Press 'Menu' and select 'Squelch'.  
Increase Squelch to filter out background noise.

### SCAN

Press 'Menu' and select 'Scan'.  
The Marine Stereo will scan the VHF preset stations for an active channel. It remains on the channel until the transmission ends, then resumes scanning.  
Press any button to interrupt. This function is disabled if no presets have been stored. See above for an explanation of saving presets.

**Note:** If the Squelch control is adjusted so you can constantly hear background noise the unit will not scan correctly.

## USB/MP3 OPERATION

### SOURCE SELECTION

Press the 'Source' button and cycle to USB (only if USB flash drive is connected).

#### PLAYING AUDIO TRACKS FROM USB FLASH DRIVES

You can store audio tracks (MP3 format only) on a USB flash drive for playback. Audio tracks can be stored in folders on the flash drive and selected for playback, as required. The flash drive must be formatted to FAT32 or NTFS (these are the most commonly used flash drive format).

Press the 'Menu' button to display the attached devices, then select the folder on your USB flash drive. Turn the encoder to navigate down the folder list and press to select.

**Note:** Press the 'Menu' button to return to the previous menu screen.

PLAY/PAUSE      Play or Pause the track



BACK/PREVIOUS      Short Press: Selects previous track  
Press and Hold: Rewind track



NEXT/FORWARD      Short Press: Selects next track  
Press and Hold: Fast-forward track



### REPEAT

Press the 'Menu' button and select 'Repeat', to repeat all playable tracks within the folder of the current selection. Default: On.

### SHUFFLE

Press the 'Menu' button and select 'Shuffle', to shuffle all playable tracks within the folder of the current selection. Default: Off.

**Important:** Ensure the USB Device is formatted as Fat32 or NTFS.

## AUX OPERATION

#### CONNECTING AN AUXILIARY AUDIO DEVICE

The Left & Right AUX RCA plugs are located on accessory cable 'B' at the rear of the unit. Connect your auxiliary audio device.

**Note:** You may require an adapter cable to connect your device. Auxiliary input adjustment:

#### ADJUSTING AUX INPUT LEVEL (dB figure)

To allow for the wide range of input levels, the AUX input has adjustable input gain (dB). The dB value is displayed on the AUX screen.

- Increase gain (volume) by pressing the Forward key (1dB steps up to 9dB)
- Decrease gain by pressing the Rewind key (1dB steps down to -9dB).

#### LISTENING TO YOUR AUXILIARY AUDIO DEVICE

Press 'Source' and cycle to AUX mode.

Start playback on your auxiliary audio device.

Use both the volume control on your auxiliary device (if available) and the volume control on the FUSION Marine Stereo to set the volume level.

# iPod/iPhone OPERATION

## CONNECTING AN iPod/iPhone

Connect a FUSION compatible Marine Dock to gain the benefits of integrated housing for your iPod or iPhone. Alternatively a certified Apple iPod sync cable can be used to connect your iPod/iPhone to the MS-RA205.



## LISTENING TO AN iPod/iPhone

Press 'Source' button and cycle to iPod. Playback of the iPod/iPhone will start automatically.

## iPod/iPhone NAVIGATION

Press the 'Menu' button to enter the iPod menu. The rotary encoder operates similar to the click wheel on your iPod. Turn to navigate and press to enter.

Note: Press the 'Menu' button to return to the previous menu screen.

<b>PLAY/PAUSE</b>	Play or Pause the track	
<b>BACK/PREVIOUS</b>	Short Press: Selects previous track Press and Hold: Rewind track	
<b>NEXT/FORWARD</b>	Short Press: Selects next track Press and Hold: Fast-forward track	

## SETTINGS

### REPEAT

Press the 'Menu' button and select 'Preferences', select 'Repeat': 

### SHUFFLE

Press the 'Menu' button and select 'Preferences', select 'Shuffle': 

## F.A.S.T

### FUSION ALPHA SEARCH TECHNOLOGY

If your iPod contains more than 50 Artists, Songs or Albums you can use F.A.S.T to quickly navigate by letter or number.

**Example:** Press the 'Menu' button and select 'Artists'. Select 'D' and the first 'Artist' beginning with 'D' will automatically highlight. Using the 'Rotary Encoder' you can then scroll up or down from this selection.

## VIDEO PLAYBACK

**Note:** Requires the optional FUSION Marine Portable Media Device Dock (MS-DKIPUSB). Featuring composite video out which enables iPod/iPhone video playback on a compatible monitor or television.

**Note:** After any IOS update to your Apple iPhone we recommend resetting the iPhone to ensure correct operation. Please follow the below procedure.

Press and hold the Sleep/Wake button and the Home button together for at least ten seconds, until the Apple logo appears.

Press the 'Menu' button to enter the iPod/iPhone menu. Select 'Videos' and navigate the menus to select a video and start playback.

## SUBTITLES

Press 'Menu' and select 'Settings'. Select 'iPod Video' then 'Subtitles'.

▶ OFF ▶ SUBTITLES ▶ CLOSED CAPTION ◀

## DISABLE SOURCES

For ease of navigation some sources (AM, AUX and VHF,) can be turned off so that they no longer display when toggling through source screens.

## NO iPod CONNECTED

If this appears on the display possible causes are:

- Ensure the iPod/iPhone is correctly connected
- Ensure the cable is not excessively bent
- The iPods battery remains low (refer to iPod manual and charge the battery)
- Reset your iPod/iPhone
- Ensure your iPod/iPhone is on the list of supported models.

(refer to [www.fusionelectronics.com](http://www.fusionelectronics.com) for a list of supported models)

## SiriusXM SATELLITE RADIO

(USA only) - Requires optional SiriusXM Vehicle Connect Tuner (not included)

Everything worth listening to is on SiriusXM, getting over 130 channels, including the most commercial-free music, plus the best sports, news, talk and entertainment. A SiriusXM Vehicle Tuner (sold separately) and Subscription are required. For more information, visit [www.Siriusxm.com](http://www.Siriusxm.com).

The MS-RA205 is ready to connect to a SiriusXM radio receiver (USA only). The SiriusXM tuner is an optional extra that must be purchased separately.

**Activating your SiriusXM tuner:** You must activate the SiriusXM tuner before you can begin to receive the SiriusXM Radio Service.

In order to activate your radio subscription, you will need the SiriusXM ID (SXID) which uniquely identifies your tuner. The 8 digit SXID is displayed on the LCD on initialization. MS-RA205 will display the SXID on Channel 0.

Power on your system and make sure that you are receiving good signal, you are able to hear audio on the SiriusXM Preview channel (Channel 1)

To listen to SiriusXM Satellite Radio, a subscription is required. Activate the SiriusXM Vehicle Tuner using one of the two methods below:

Online: Go to [www.Siriusxm.com/activatenow](http://www.Siriusxm.com/activatenow)

Phone: Call 1-866-635-2349

## SiriusXM OPERATION

Press 'Source' to cycle to the SiriusXM Satellite radio source.

## SiriusXM NAVIGATION

Press the 'Menu' button and navigate the functions.

## CHANNELS

Select the desired channel (listed in channel order) and music preference

## **CATEGORY**

Select the desired genre type. (The unit will only play the selected option)

## **PADLOCK ICON**

The padlock icon means the channel is locked or considered mature content. If you select this channel you will be asked to unlock parent mode, if it is not already unlocked.

## **PRESET TUNING MODE**

Press 'Play' to cycle to preset tuning mode. Press the 'Previous' or 'Next' button to select previous or next preset.

Note: Preset function is only available when more than one preset has been saved.

## **PRESETS**

Add your channel preset to your favourites list by selecting 'Add Preset' (Maximum 30 channels). Remove channels by selecting 'Remove Preset'. Select 'All' or the individual channel. Exit by pressing the 'Menu' button.

Alternatively: Press and hold the 'Play' button to store favourite.

# PARENTAL MODE

## **ENABLE ON/OFF**

Select to enable channels to be locked/unlocked

## **PIN #**

Turn the 'Rotary Encoder' to select number and press to enter, repeat to enter the 4 digit code. (Factory setting is 0000)

Note: Must be entered before the following items are operational.

## **LOCK / UNLOCK**

Select the channel to be locked or unlocked

## **CHANGE PIN**

Personalise your Pin number. (4 digits max)

## **PIN RESET**

When on SiriusXM source, press & hold mute key for 15 seconds. PIN will be reset to '0000'.

# ZONE OPERATION

The MS-RA205 Marine Stereo features Multi-Zone technology which enables 2 'Zones' with independent volume control.

## ZONE SETUP

Press the 'Menu' button and select 'Settings'. Select 'Zones' then the Zone you wish to setup.

### **BALANCE**

Select 'Balance' to adjust the balance from left to right.

### **VOLUME LIMIT**

Select 'Volume Limit' to set the desired maximum output volume for each individual Zone.



## SUBWOOFER

Adjust the sub limit and filter.

**Note:** From any source screen press and Hold the `Rotary Encoder` for quick access to subwoofer level adjustment

### SUB LIMIT

Press the `Menu` button and select `Zones`. Select `Subwoofer` then `Sub Limit`. Select the desired maximum subwoofer output volume.

### SUB FILTER

Press the `Menu` button and select `Zone`. Select `Subwoofer` then `Filter`. Select the desired frequency. 55Hz - 85Hz - 120Hz - 160Hz

**Note:** Subwoofer and Lineout volume control is linked to Zone 1.

## ADDITIONAL FEATURES

### FUSION-Link

FUSION-Link has the ability to fully control on-board FUSION Entertainment systems (Supported models), by utilizing FUSION-Link capable multi-function displays installed at the helm, flybridge or nav station of the vessel, providing integrated entertainment control and a less cluttered console.

You can control one or more FUSION-Link capable stereo units from a single location on the boat with the touch of a button. FUSION-Link operates over existing industry standard networks including NMEA2000 .

Link Zones or manage the entire audio system from the steering station on the boat. The partnered multi-purpose display becomes the portal to which all audio on the vessel is controlled, no matter where on the vessel the stereo is installed. The FUSION-Link equipped stereo can be installed out of sight if space is an issue and users need to visit the unit only to replace removable media.

For a list of FUSION-Link capable products from companies that are partnering with FUSION, please visit [www.fusionelectronics.com](http://www.fusionelectronics.com) for further details.

### WIRED REMOTE

The MS-RA205 Marine Stereo can be controlled by MS-NRX200 wired remote controls installed in the various audio Zones throughout the vessel. There are different cable requirements depending on whether the MS-RA205 and remote controls are connected to an existing NMEA2000 bus or in a FUSION-only installation.

### NMEA-2000 BUS INSTALLATION

FUSION's MS-NRX200 wired remote controls can connect to the NMEA 2000 bus, removing the need to wire back to the stereo unit. The communication is both ways, as FUSION's MS-NRX200 remote can display NMEA data like depth, speed and wind direction on the remote's screen. You will require a FUSION NMEA 2000 starter kit (MS-N2KSTART) to create a NMEA Bus. To connect the remote to the existing NMEA 2000 Bus, you will require a FUSION NMEA 2000 Connection pack (MS-N2KCONN).

# FUSION-ONLY INSTALLATION

Smaller or older vessels without NMEA 2000 can still have FUSION MS-NRX200 wired remotes in almost any location. No starter kit is required as the MS-NRX200 wired remote package includes everything necessary to connect it directly to the MS-RA205 Marine Stereo.

## MENU STRUCTURE

### ROOT MENU

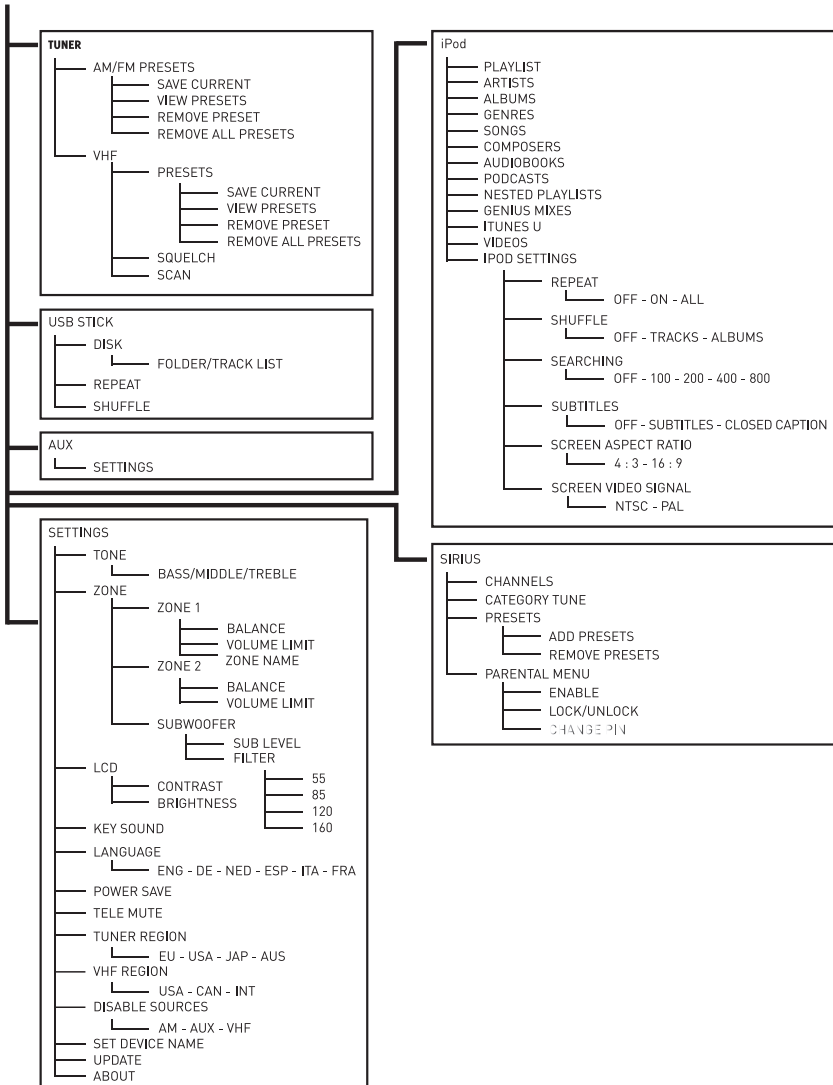

## TROUBLESHOOTING

### RESET

Should the stereo become unresponsive. Follow the below steps:

1. Press and hold the 'Power' button for 10 seconds to reset the stereo.
2. Reset your iPod/iPhone
3. Remove all power for 1 minute and then reconnect.
4. If you are unable to correctly tune to radio stations, check you have the correct tuner region selected.

### FACTORY RESET

The factory reset function will return all settings in the MS-RA205 to the factory default value.

**Warning:** All AM, FM and VHF station presets are erased. Tuner and VHF tuner regions are reset to USA. All zones are enabled and zone settings, tone, subwoofer filter settings, source settings and device name are returned to default values.

**To reset your MS-RA205 to factory default values:**

1. Press the Menu Key.
2. Select **Settings → Update**. Select **Factory reset**. All settings will be restored to the factory default. At the completion of the reset process the stereo will automatically power down and restart.

### iPod

**Why does my FUSION Head unit keep locking up when connected to my iPod/iPhone?**

If you are experiencing software lock-ups or your unit freezes:

- Reset the Head unit by pressing the reset button inside the face plate.
- Reset your iPod/iPhone (see Apple website from model-specific information). This should resume normal operation.
- Make sure you have the latest version of iTunes and the latest operating software in your iPod/iPhone. It is important to update software when Apple releases new versions. If you are connected via a dock, ensure you are using the correct sleeve and the connection to the Head unit is secure.

**Will my iPod/iPhone connect to my FUSION product if the battery is flat?**

No. It will take a number of minutes for the Apple product to get a minimum level of charge before it can connect and become operational. Please connect and wait for the unit to initialise.

**My iPod/iPhone will not connect to the head unit while in a FUSION dock accessory.**

If your Head unit displays "Not Connected" while using iPod as input source:

- Check that you are using the correct sleeve combination. If you have the incorrect sleeve combination this could prevent the iPod connector from mating correctly. It could also damage the connector in the dock or your iPod/iPhone itself.

If you are uncertain which iPod model you have, go to <http://www.apple.com/support/> to get the correct model information for your iPod.

If you are still unable to connect once you know for certain you have the correct iPod/iPhone-sleeve combination:

- Ensure that you have the latest version of operating software installed in your iPod/iPhone and the latest iTunes version. To do this, connect your iPod/iPhone to iTunes and it will check and, if necessary, prompt you to download the latest version.

**If you are still unable to connect once you have confirmed that you have the latest software or you have updated your iPod/iPhone:**

- Reset the iPod/iPhone (see the user manual for your Apple product) and also reset the Head unit (see FUSION user manual).

**If you are still unable to connect:**

- Contact your FUSION dealer or contact FUSION via the tech email on the FUSION website.

## SiriusXM

**When I press the tuner source button the SiriusXM screen is not displayed.**

- Ensure you have the MS-RA205 Tuner region set to `USA`.  
Click Menu - Settings - Tuner region - select `USA`.
- Ensure the SiriusXM module is plugged into the MS-RA205.
- Unplug the SiriusXM module and check the pins in the SiriusXM plug are not damaged.

**SiriusXM message: `Check Tuner`**

- Ensure the SiriusXM module is plugged into the MS-RA205.
- Ensure the SiriusXM cable has not been damaged.

**SiriusXM message: `Check Antenna`**

- Ensure the antenna is plugged into the SiriusXM Tuner module.
- Ensure the antenna is not damaged.
- Ensure the antenna cable has not been damaged

**SiriusXM message: `No Signal`**

- Ensure the antenna is not damaged.
- Ensure the antenna has a clear view of the sky and is not obscured.
- Ensure the antenna cable has not been damaged

**SiriusXM message: `Channel xx Not Available`**

A SiriusXM message informing you that the current channel is unavailable. Possible causes are SiriusXM has removed the channel or your SiriusXM subscription has changed.

- Contact SiriusXM to update your subscription.
- Online: Go to [www.siriusxm.com/subscriptions](http://www.siriusxm.com/subscriptions)
- Phone: Call 1-866-635-2349

**SiriusXM message: `Channel xx Unsubscribed`**

- Contact SiriusXM to update your subscription.
- Online: Go to [www.siriusxm.com/subscriptions](http://www.siriusxm.com/subscriptions)
- Phone: Call 1-866-635-2349

**SiriusXM message: `Subscription Updated`**

• A SiriusXM message informing you that you have either been granted access to or unsubscribed from various channels.

For more information about your subscription:

- Online: **Go to [www.siriusxm.com/subscriptions](http://www.siriusxm.com/subscriptions)**
- Phone: **Call 1-866-635-2349**

## FUSION MARINE ACCESSORIES

### NMEA 2000 CONNECTION KIT MS-N2KCONN

Connect the FUSION MS-RA205 Marine Stereo or MS-NRX200 Wired Remote Control to an existing NMEA 2000 network with the addition of the MS-N2KCONN Connection Kit. Contents Include: 1 x FUSION to NMEA 2000 Drop Cable and 1 x NMEA 2000 T-Connector.



### MARINE PORTABLE MEDIA DEVICE DOCK MS-DKIPUSB

Connect a Marine Portable Media Device Dock (MS-DKIPUSB) to provide an integrated housing for your iPod or iPhone, protecting them from the harsh marine environment. Video playback from your iPod/iPhone and two USB ports for portable flash drive playback. The dock can be flush or wall mounted.



### MARINE ACTIVE SUBWOOFER MS-AB206

Features a down firing bass reflex enclosure and its own internal Active 210 Watt amplifier allowing easy connection to the music source delivering crisp clear low frequency reproduction from any music selection.



### MARINE WIRED REMOTE MS-NRX200

The Marine Wired Remote Control extends the capabilities of our Stereo by enabling local control of the audio in each zone of your vessel. Up to two remote's can be linked to the Stereo, providing true system flexibility.



### MARINE ZONE AMPLIFIER MS-AM702

The Marine 2x70 Watt D-Class Zone Amplifier is designed to support the Multi-Zone technology of the Marine Stereo. The Zone Amplifier is small, enabling discrete installation and when combined with the Marine Stereo provides the platform for a True Multi-Zone audio system.



### MARINE 5 CHANNEL AMPLIFIER MS-DA51600

Add more power and increase the bass level of your music of your FUSION Marine Audio System by connecting a 5-Channel Amplifier. Built for the harsh marine environment with conformal coated PCB and stainless steel end panels.



# SPECIFICATIONS AND LICENSING

## SPECIFICATIONS

### CHASSIS DIMENSIONS

Depth 93mm - 3-5/8"  
 Width 130mm - 5-1/16"  
 Height 50mm - 2"

### FACE PLATE DIMENSIONS

Depth 29mm - 1-1/8"  
 Width 157mm - 6-3/16"  
 Height 68mm - 2-11/16"

### OPERATING VOLTAGE:

10 - 16VDC Negative ground

### FUSE RATING:

15 Amp

### OUTPUT POWER:

50 Watts x 4 (Max)

### SPEAKER IMPEDANCE:

4 Ohms per channel

### PRE - OUTPUT VOLTAGE:

3V

## FCC COMPLIANCE STATEMENT

This device complies with part 15 of the FCC rules. Operation is subject to the following two conditions:

This device may not cause harmful interference **AND** This device must accept any interference received, including interference that may cause undesired operation.

## TUNING RANGE

### EUROPE AND AUSTRALASIA:

FM Radio	AM Radio
Frequency Range: 87.5 - 108 MHz	Frequency Range: 522 - 1620 kHz
Frequency step: 50 kHz	Frequency step: 9 kHz

### USA

FM Radio	AM Radio
Frequency Range: 87.5 - 107.9 MHz	Frequency Range: 530 - 1710 kHz
Frequency step: 200 kHz	Frequency step: 10 kHz

### JAPAN

FM Radio	AM Radio
Frequency Range: 76 - 90 MHz	Frequency Range: 522 - 1620 kHz
Frequency step: 50 kHz	Frequency step: 9 kHz

### VHF TUNING RANGE

All Regions:

Frequency Range: 156 - 164 MHz

The following additional channels are available within each specific VHF tuner region (Please refer to selecting the VHF tuner region on pg. 12).

Designator	Frequency
<b>USA Region</b>	
01 Wx	162.550
02 Wx	162.400
03 Wx	162.475
04 Wx	162.425
05 Wx	162.450
06 Wx	162.500
07 Wx	162.525
<b>Canada Region</b>	
01 Wx	162.550
02 Wx	162.400
03 Wx	162.475
<b>International Region</b>	
M1 (only transmitted in Britain)	157.850
M2 (only transmitted in Britain)	161.425

## LICENSING

Apple, the Apple logo, iPod, iPhone, 'Made for iPod' and 'Made for iPhone' are Trademarks of Apple Computer, Inc., registered in the U.S. and other countries.

SiriusXM, XM and all related marks and logos are trademarks of SiriusXM Radio Inc. All rights reserved.

NMEA 2000 is a registered Trademark of the National Marine Electronics Association, Inc.



PUBLISHED BY FUSION ELECTRONICS LIMITED. © Copyright 2013 by FUSION Electronics Limited. All rights reserved. Specifications and design are subject to change without notice. YOU CAN HELP PROTECT THE ENVIRONMENT Please remember to respect the local regulations: Hand in the non-working electrical equipment to an appropriate waste disposal centre. v1.0

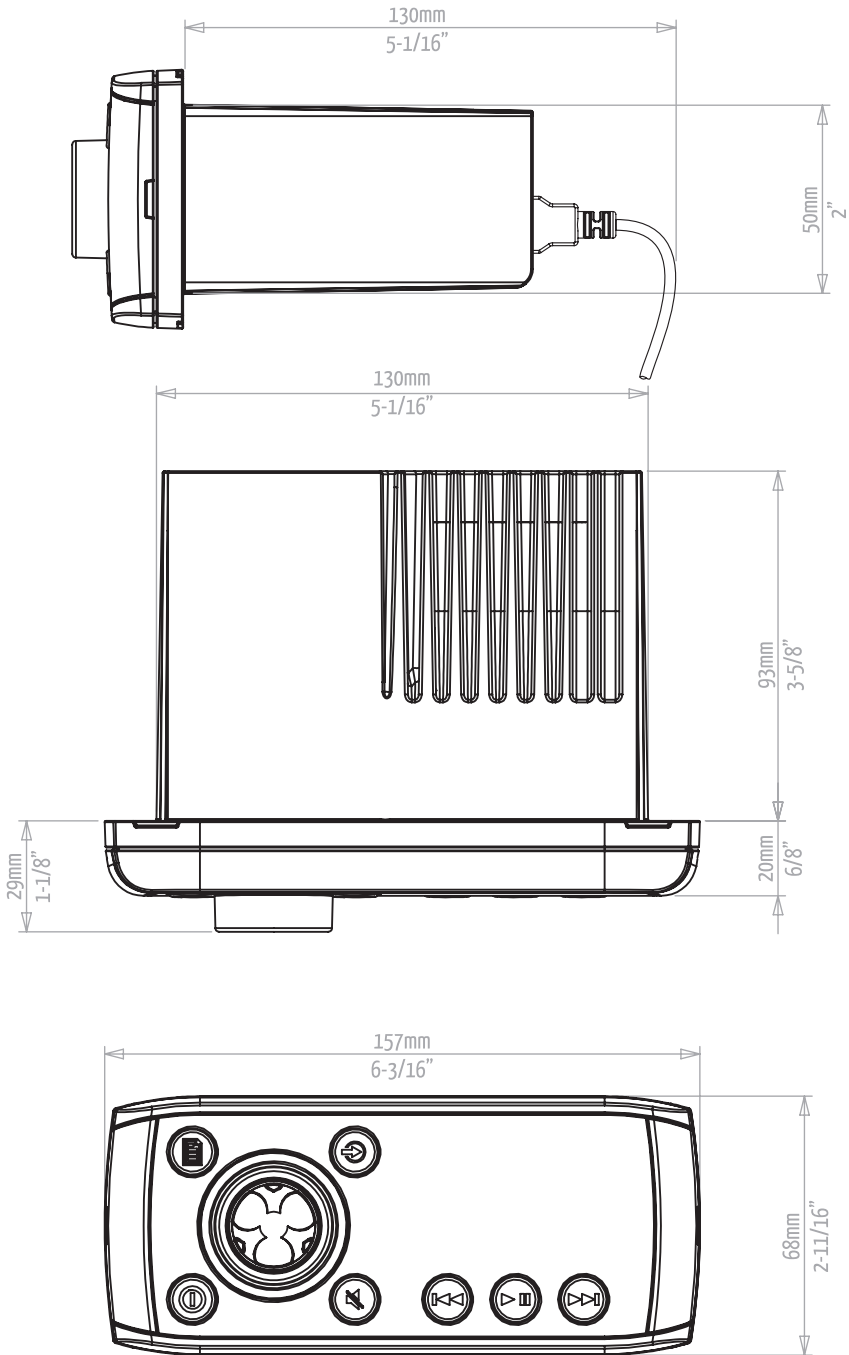



**FUSION<sup>®</sup>**

**[WWW.FUSIONELECTRONICS.COM](http://WWW.FUSIONELECTRONICS.COM)**

FUSION Electronics New Zealand	09 369 2900
FUSION Electronics Australia	1300 736 012
FUSION Electronics Europe	+31 76 5723 632
FUSION Electronics USA	623 580 9000
FUSION Electronics Pacific	+64 9 369 2900